



LAZER

Lamorinièrestraat 33-37
2018 Antwerp - Belgium
www.lazersport.com

LAZER

LED light

USER MANUALS

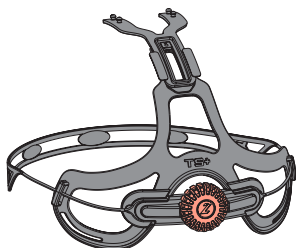

1. Gently pry the hooked cap away from the retention system.

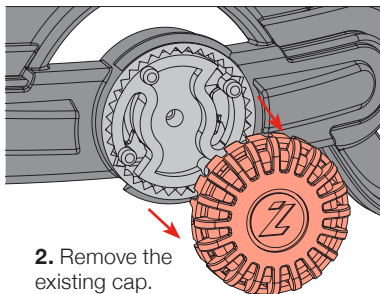
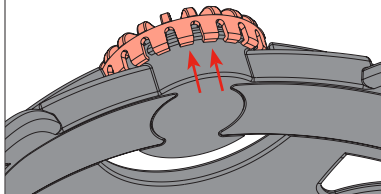

2. Remove the existing cap.

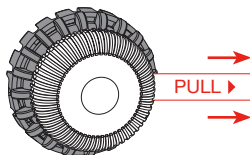

3. Remove the battery insulation tab.

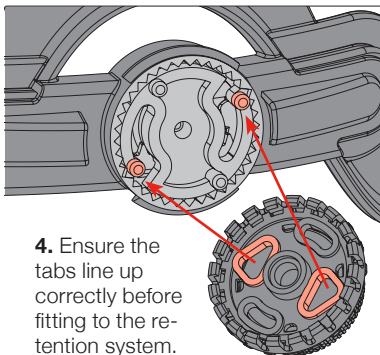

4. Ensure the tabs line up correctly before fitting to the retention system.

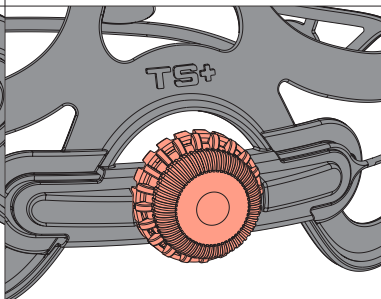

5. Push the LED cap until you hear "click". It's now installed.

For a video guide to help with the following steps please go to the following URL and click on how to videos:

www.youtube.com/user/LazerSport

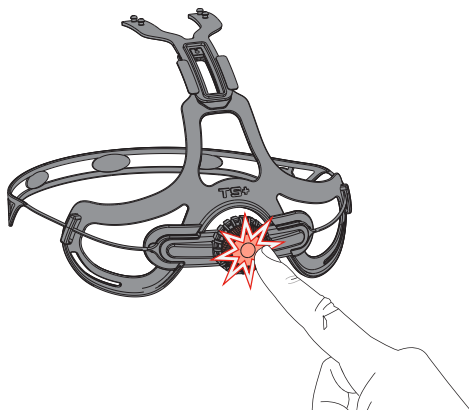

1. Press the light button.



1: Constant mode



2: Flash mode



3: Off

3. How to change the battery

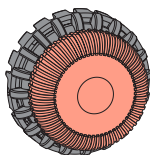

1. Remove
clear cap.

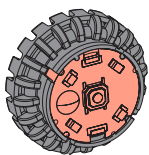

2. Release the
lighting module.

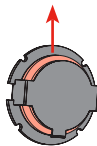

3. Slide the
battery out.

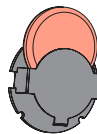

4. Change
battery.

For a video guide to help with the following steps please go to the following URL and click on how to videos:

www.youtube.com/user/LazerSport

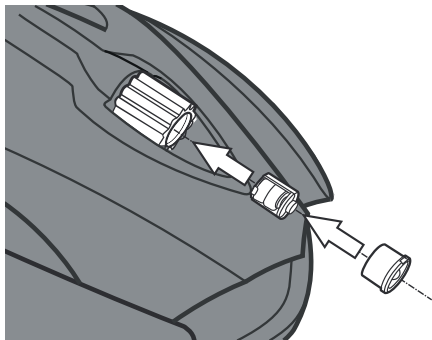

1. Insert the battery pack into the rear of the Rollsys® system, with the green PCB board facing outwards.

2. Insert the clear silicone cap into the rear of the Rollsys® system, sealing the electronics.

2. Light modes

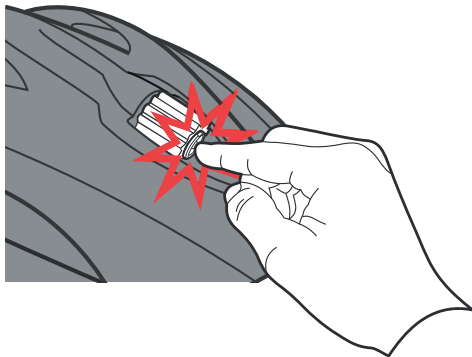

1. Press the light button.



1: Constant mode



2: Flash mode



3: Off

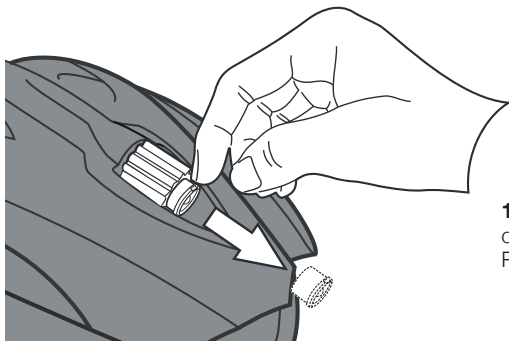

1. Pull out the silicone cap from the rear of the Rollsys® system.



2. Remove the battery pack.

2. Slide the batteries out of the cage.

3. Replace the LR41 button cell batteries.

4. Follow installation steps in reverse to replace battery pack and cap.

For a video guide to help with the following steps please go to the following URL and click on how to videos:
www.youtube.com/user/LazerSport

1. Remove the existing cap.

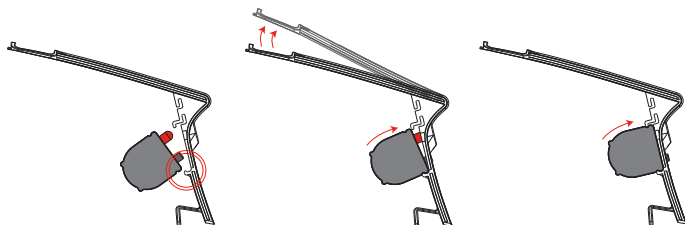

1a. Insert the lower tongue of the Mudcap into the groove of the led.

1b. Gently lift the upper section of the Mudcap, whilst rotating the led into position.

1c. The led is now firmly installed into the Mudcap.

2. Install the Mudcap into the helmet.

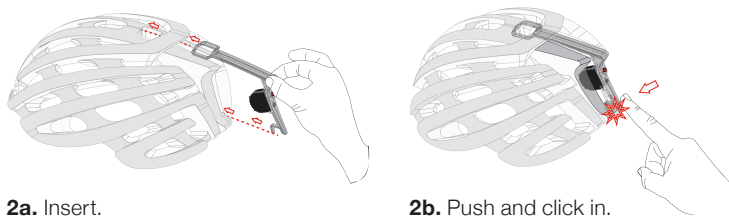

2a. Insert.

2b. Push and click in.

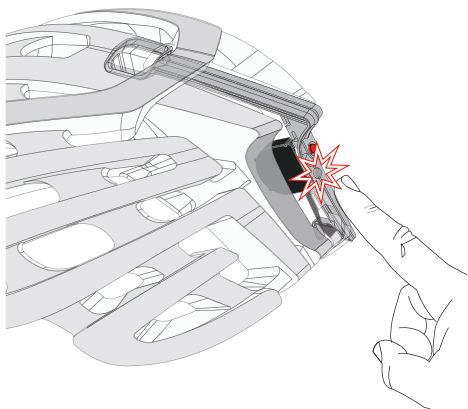

1. Press and hold the light button to activate the light.



1: Constant mode



2: Flash mode



3: Off

3. How to charge the battery

The LED battery light for the Lazer Mudcap should be fully charged when you take it out of the box.

After approximately 37 hours of use on flashing mode you will need to recharge your battery.

To do this you will need to remove it from the helmet.

1. Remove the LED light from the Mudcap by following installation steps in reverse.

3. Now plug the battery in to any USB port using the cable provided.

4. Replace the LED and Mudcap by following the installation steps.

Approximate run times:
Still mode is 5.25 hours.
Flashing mode is 37 hours.

Recharging time is 1.5 hours.